

THE PROPERTY OF THE DRAWING IS ESTABLISHED BY LAW. IT IS FORBIDDEN TO PRODUCE OR SHOW IT TO THIRD PARTY, WITHOUT A WRITTEN AGREEMENT.

Item	Name	Q.ty
1	CA.08.09.05	1
2	CA.08.09.028	1
3	CA.08.39.003	1

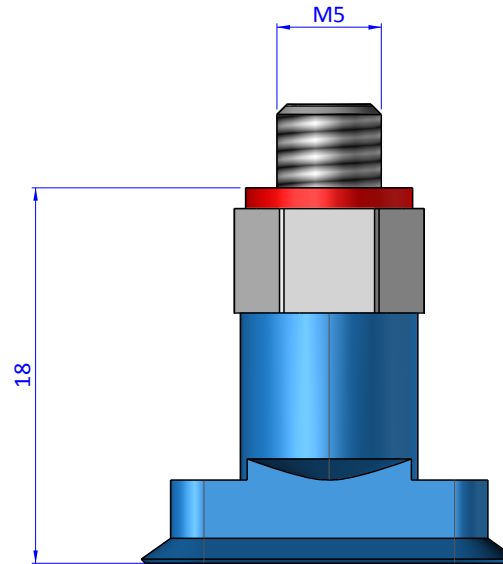
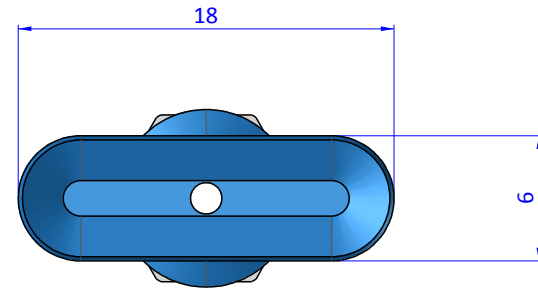
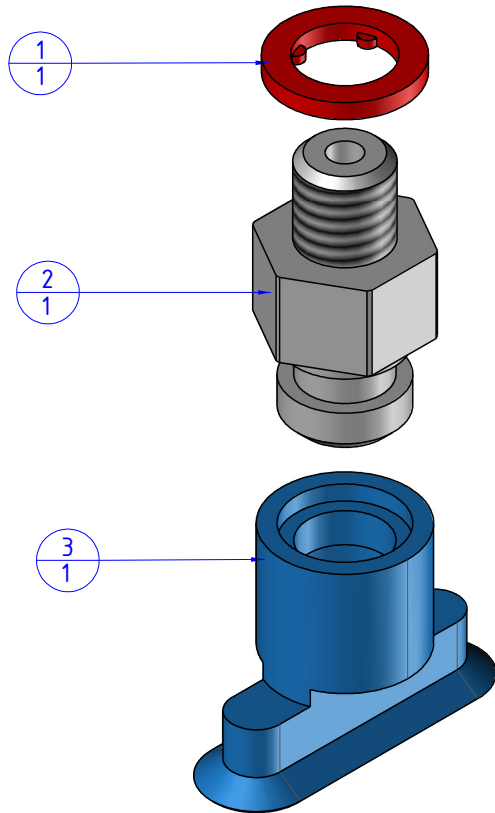

Format A3

UNI 936-76

		DESIGNED FROM		REVIEW
		FPS Automation		A
GENERAL TOLERANCE		DATE	WEIGHT	
UNI - ISO 2768		21/03/2019	0,001kg	
CLASSE f	DESCRIPTION	CODE		
	KIT.08.39.L18.28	KIT.08.39.L18.28		